

1565 - (5) Tier Shoe and Boot Rack 14"D x 63"H x 33"W

Read all instructions completely before installing. Should you have any questions about your installation, please call Customer Service at 440-248-5480. Missing and damaged parts must be reported within 5 days from receipt of delivery.

Tools needed for this installation (Not Supplied with Kit)

Level - Pencil or marker - Phillips head screw driver – ½" Standard drill bit for hollow wall installation – Safety glasses – 5/16" Masonry bit for concrete block installation – 1/16" Standard drill bit for stud wall installation – Tape measure

Parts Listing

P/N#	Qty	Description	Qty	Qty
Hardware				
10-01815T	1	Top Track Sections	5	2-1/2" Bolts
10-0280-1T	2	Top Hang Rail with hanging Slots	6	3-1/2" Bolts
10-0280-2T	2	Bottom Hang Rail Section	11	White Plastic Wall Anchors
10-0280-3T	2	Hang Rail Connector with 2 bolts	11	2-1/4" Wood Screws
10-2004T	5	Shoe Racks	11	Toggle Bolt Expanders
			1	Hex Head Wrench for Hang Rails

We have included all mounting hardware for hollow and concrete block wall installations. It is not necessary to mount system to wood studs. Each system will require 35 linear Inches of wall space for mounting and a minimum ceiling height of 7-1/2 feet high for proper clearance.

Drill Diameter Listing: Drill diameter sizing for hollow wall installations: Use 1/2" standard drill bit
 Drill diameter sizing for concrete wall installations: Use 5/16" masonry drill bit
 Drill diameter sizing for wood Stud wall installations: Use 1/16" standard drill bit for pilot holes

Preparation for Top Track Installation: (Image A-1)

1. When installing in a corner, leave 1" space between side wall and your top track.
2. Determine the maximum height of storage you would like available above your system. (See Fig. A-1). For an 8 foot ceiling; 78" off the floor leaves 18" of storage above and 81" leaves 15" storage above.
3. Using a tape measure, mark your desired height off the floor with a 4" long pencil mark.
4. (Refer to Fig. A-1 & A-2) Using a level, align top of top track with your pencil mark in step 3. With top track level, mark the center of each hole's location on your wall. (Note: Before starting to drill holes always make sure all screw hole locations do not fall in line with electrical wires, duct work or plumbing inside of your wall. If a potential problem exists, reposition and remark screw hole locations.)
5. (Fig. A-2) Drill hole locations marked using the correct drill diameter sizing and type listed above. Should you come in contact with wood studs, stop and mark the hole with X and after drilling all other holes come back and drill these holes using a 1/16" bit for pilot hole for wood screws.

Attachment of Top Track to Wall Surfaces: (Fig. A-3)

6. For hollow walls; (Fig. A-3) Use 2-1/2" long toggle bolts with expanders. Insert all toggle bolts through top track and attach all toggle bolt expanders. Omit toggle bolts that fall in line with X or wood studs. Insert toggle bolts with expanders into holes in wall before starting step 9.
7. For concrete walls; use white plastic wall anchors and 2-1/4" long wood screws. Install all plastic wall anchors in all hole locations before starting step 9.

8. For wood studs use 2-1/4" long wood screws. Always install wood screws last and there will be no need to use plastic wall anchors.
9. Using a level and holding top track in place tighten one of the end toggle bolts or wood screws until snug. (Allow for track movement).
10. Making sure top track is still level, tighten toggle bolt or install wood screw on the opposite end until fully secure and then go back and fully tighten the first toggle bolt.
11. Install and fully tighten all remaining toggle bolts or wood screws.
Hang Rail Assembly: (Fig. B-1) Assemble (2) 63" long hang rail assembly consisting of 3 parts, (A) Top Slotted section (B) Bottom rail section and (C) Hang rail connector with 2 bolts.
Hanging Hang Rails: (Fig. B-2, and B-4). Note: When installing hang rails, work from left to right or right to left and always installing one hang rail at a time.
12. (Fig. B-2 and B-3) Slide each hang rail assembly onto front lip of the top track. Position each hang rail at opposite ends of the track.
13. Starting from one end, make sure the top outside edge of the hang rail is no greater than 1/8" away from the outside vertical straight edge of the top track. Using a level, make sure hang rail is flat against wall surface and straight; while holding in place mark the centers of the 3 bolt holes locations onto the wall.
14. Drill locations marked in Step 13 using the correct drill bit for your type of wall surface. (Refer to drill diameter listing above.) Note: Should you come in contact with a wood stud stop drilling and mark hole with an X. After drilling all other holes come back to the X and using a 1/16" bit, create pilot hole for wood screw installation.
Attaching Hang Rails to Wall Surfaces; (Fig. B-4 thru B-6)
15. Hollow walls: Use 3-1/2" long toggle bolts with expanders. Remove hang rail from top track, and insert toggle bolts through holes in hang rail and attach all toggle bolt expanders. Re-install hang rail and insert toggle bolts with expanders into holes in wall before starting step 18.
16. Concrete walls: Use white plastic wall anchors and 2-1/4" long wood screws. Install all plastic wall anchors in holes before starting step 18.
17. Wood studs: Use 2-1/4" long wood screws.
18. Using a level and keeping hang rail straight, tighten bolts.
Second Hang Rail Attachment: (Fig. B-4 thru B-6)
19. Slide the second hang rail to the opposite end of top track. Inside spacing between hang rails should be 30.25" (30-1/4").
20. Using a level, make sure your second hang rail is straight and that you have easy removal of tool board and combination rail from both hang rails mark the centers of the bolt holes onto your wall surface.
21. Drill out holes for your wall surface and complete installation by following steps 15-18.
22. Accessory Installation: Always make sure you're installing all accessories level and into the identical height slots in both hang rails. Binding can occur if not level. All accessories will be installed in the inside slot positions of each hang rail. If accidental binding occurs use soft rubber mallet to help remove accessory and protect the paint.

Warranty Information: All steel components are guaranteed free of defect for the life of the product. Return defective parts only postage pre-paid along with copy of your original purchase receipt to:

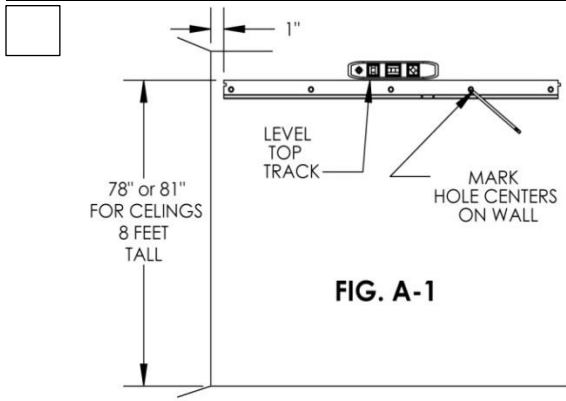

FIG. A-1

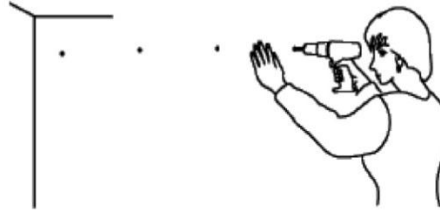
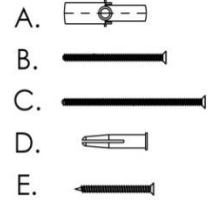

FIG. A-2

- A. TOGGLE BOLT EXPANDER
- B. 2 1/2" TOGGLE BOLT
- C. 3 1/2" TOGGLE BOLT
- D. PLASTIC WALL ANCHOR
- E. 2 1/4" WOOD SCREW



**DRILL DIAMETER:
HOLLOW WALL: 1/2"
CONCRETE BLOCK: 5/16"**

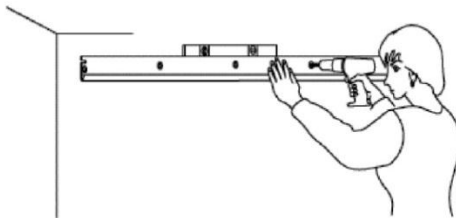
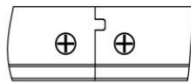
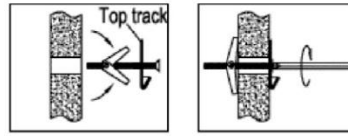
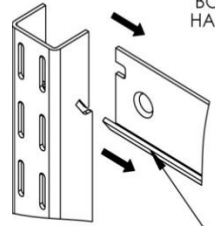
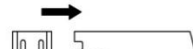

FIG. A-3



TOP TRACKS
IN "LOCKED"
POSITION

FIG. A-4



TOP TRACK LIP

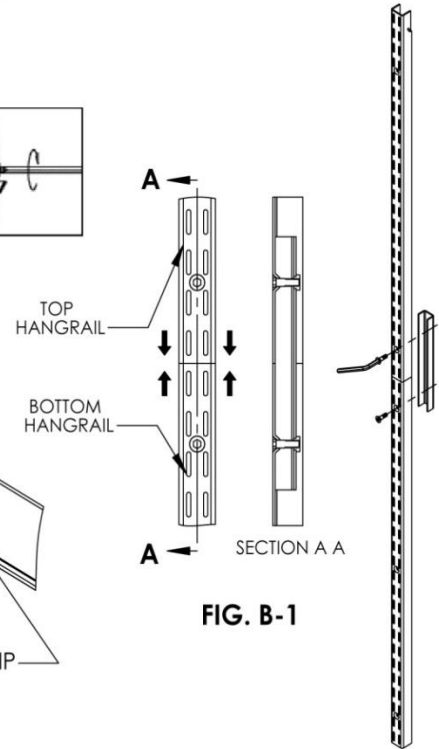

FIG. B-1

**DRILL DIAMETER:
HOLLOW WALL: 1/2"
CONCRETE BLOCK: 5/16"**

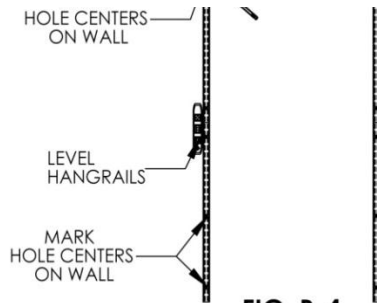

FIG. B-4

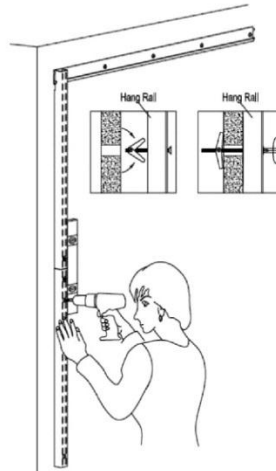

FIG. B-5

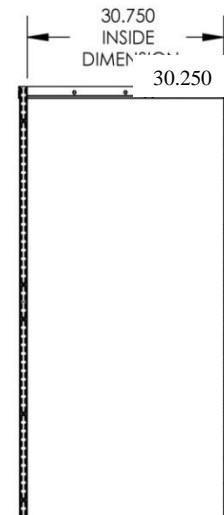

FIG. B-6

Please contact our Customer Service Division with any questions at:
30700 D Carter Street · Solon, OH 44139 · (P) 440.248.5480 · support@tritonproducts.com

For a full line of products visit www.tritonproducts.com

Fig. C-1

Metal Shelf Bracket installation and hanging installation

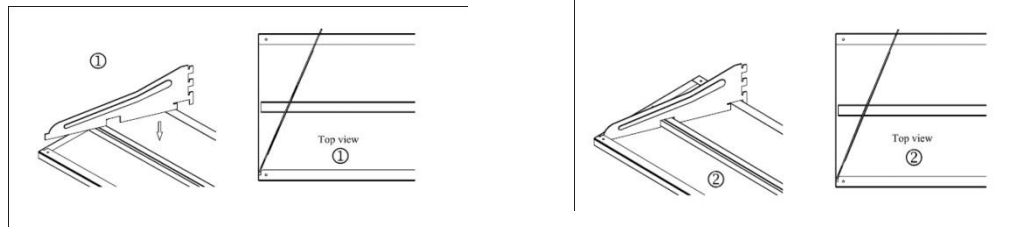

Slot on front lip of shelf

